

# User Manual

Revision 1.200  
English

## Modbus / CAN – Datalogger

(Order Code: HD67324-B2-E-232-4GB, HD67324-B2-E-485-4GB, HD67324-B2-E-CAN-4GB)

for Website information:

[www.adfweb.com?Product=HD67324](http://www.adfweb.com?Product=HD67324)

for Price information:

[www.adfweb.com?Price=HD67324-B2-E-232-4GB](http://www.adfweb.com?Price=HD67324-B2-E-232-4GB)

[www.adfweb.com?Price=HD67324-B2-E-485-4GB](http://www.adfweb.com?Price=HD67324-B2-E-485-4GB)

[www.adfweb.com?Price=HD67324-B2-E-CAN-4GB](http://www.adfweb.com?Price=HD67324-B2-E-CAN-4GB)

### Benefits and Main Features:

- ⊕ Very easy to configure
- ⊕ Electrical isolation
- ⊕ Temperature range: -40°C/85°C (-40°F/185°F)



For other M-Bus products:

See also the following link:

**Converter M-Bus to**

[www.adfweb.com?Product=HD67021](http://www.adfweb.com?Product=HD67021) **(RS232)**

[www.adfweb.com?Product=HD67022](http://www.adfweb.com?Product=HD67022) **(RS485)**

[www.adfweb.com?Product=HD67030](http://www.adfweb.com?Product=HD67030) **(Ethernet)**

**Extender and Repeater, M-Bus**

[www.adfweb.com?Product=HD67032](http://www.adfweb.com?Product=HD67032)

**Gateway M-Bus / Modbus RTU**

[www.adfweb.com?Product=HD67029M-232](http://www.adfweb.com?Product=HD67029M-232) **(on RS232)**

[www.adfweb.com?Product=HD67029M-485](http://www.adfweb.com?Product=HD67029M-485) **(on RS485)**

**Gateway M-Bus / Modbus TCP**

[www.adfweb.com?Product=HD67044-B2](http://www.adfweb.com?Product=HD67044-B2)

**Gateway M-Bus / CANopen**

[www.adfweb.com?Product=HD67051](http://www.adfweb.com?Product=HD67051)

**Gateway M-Bus / PROFIBUS**

[www.adfweb.com?Product=HD67053M](http://www.adfweb.com?Product=HD67053M)

Do you have an your customer protocol?

See the following link:

[www.adfweb.com?Product=HD67003](http://www.adfweb.com?Product=HD67003)

Do you need to choose a device? do you want help?

Ask it to the following link:

[www.adfweb.com?Cmd=helpme](http://www.adfweb.com?Cmd=helpme)



User Manual

**INDEX:**

	Page
INDEX	2
UPDATED DOCUMENTATION	2
REVISION LIST	2
WARNING	2
TRADEMARKS	2
SECURITY ALERT	3
CONNECTION SCHEME	4
CONFIGURATION	7
CHARACTERISTICS	7
POWER SUPPLY	8
FUNCTION MODES	9
LEDS	10
RS232	12
RS485	13
CAN	14
ETHERNET	15
USE OF SW67324	16
NEW CONFIGURATION	17
LOAD CONFIGURATION	18
SAVE CONFIGURATION	19
UPDATE DEVICE	20
SOFTWARE PREFERENCES	23
CONFIGURATION SETTING	24
DOWNLOAD DATA	32
DATE & TIME SETTINGS	34
WEBSERVER INTERFACE	35
MECHANICAL DIMENSIONS	40
ORDERING INFORMATIONS	41
ACCESSORIES	42
DISCLAIMER	43
OTHER REGULATIONS AND STANDARDS	43
WARRANTIES AND TECHNICAL SUPPORT	44
RETURN POLICY	44

**UPDATED DOCUMENTATION:**

Dear customer, we thank you for your attention and we remind you that you need to check that the following document is:

- Updated
- Related to the product you own

To obtain the most recently updated document, note the "document code" that appears at the top right-hand corner of each page of this document.

With this "Document Code" go to web page [www.adfweb.com/download/](http://www.adfweb.com/download/) and search for the corresponding code on the page. Click on the proper "Document Code" and download the updates.

**REVISION LIST:**

Revision	Date	Author	Chapter	Description
1.002	07/02/2013	Nt	All	Added new chapters
1.003	20/05/2013	Fl	All	Add USB driver location
1.100	23/12/2015	Ff	All	Added Ethernet version
1.200	22/12/2017	Ff	All	Added CAN version

**WARNING:**

ADFweb.com reserves the right to change information in this manual about our product without warning.

ADFweb.com is not responsible for any error this manual may contain.

**TRADEMARKS:**

All trademarks mentioned in this document belong to their respective owners.

**SECURITY ALERT:****GENERAL INFORMATION**

To ensure safe operation, the device must be operated according to the instructions in the manual. When using the device, legal and safety regulation are required for each individual application. The same applies also when using accessories.

**INTENDED USE**

Machines and systems must be designed so the faulty conditions do not lead to a dangerous situation for the operator (i.e. independent limit switches, mechanical interlocks, etc.).

**QUALIFIED PERSONNEL**

The device can be used only by qualified personnel, strictly in accordance with the specifications. Qualified personnel are persons who are familiar with the installation, assembly, commissioning and operation of this equipment and who have appropriate qualifications for their job.

**RESIDUAL RISKS**

The device is state-of-the-art and is safe. The instruments can represent a potential hazard if they are inappropriately installed and operated by untrained personnel. These instructions refer to residual risks with the following symbol:



This symbol indicates that non-observance of the safety instructions is a danger for people that could lead to serious injury or death and / or the possibility of damage.

**CE CONFORMITY**

The declaration is made by our company. You can send an email to [support@adfweb.com](mailto:support@adfweb.com) or give us a call if you need it.

**CONNECTION SCHEME:**

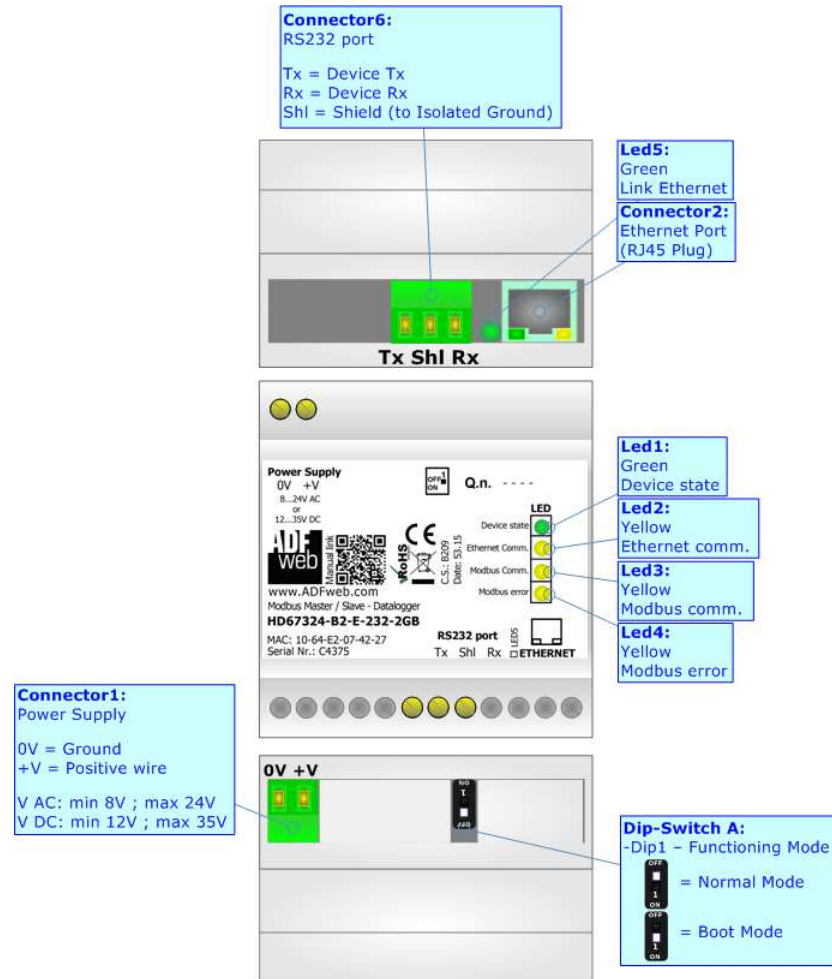

Figure 1a: Connection scheme for HD67324-B2-E-232-xGB

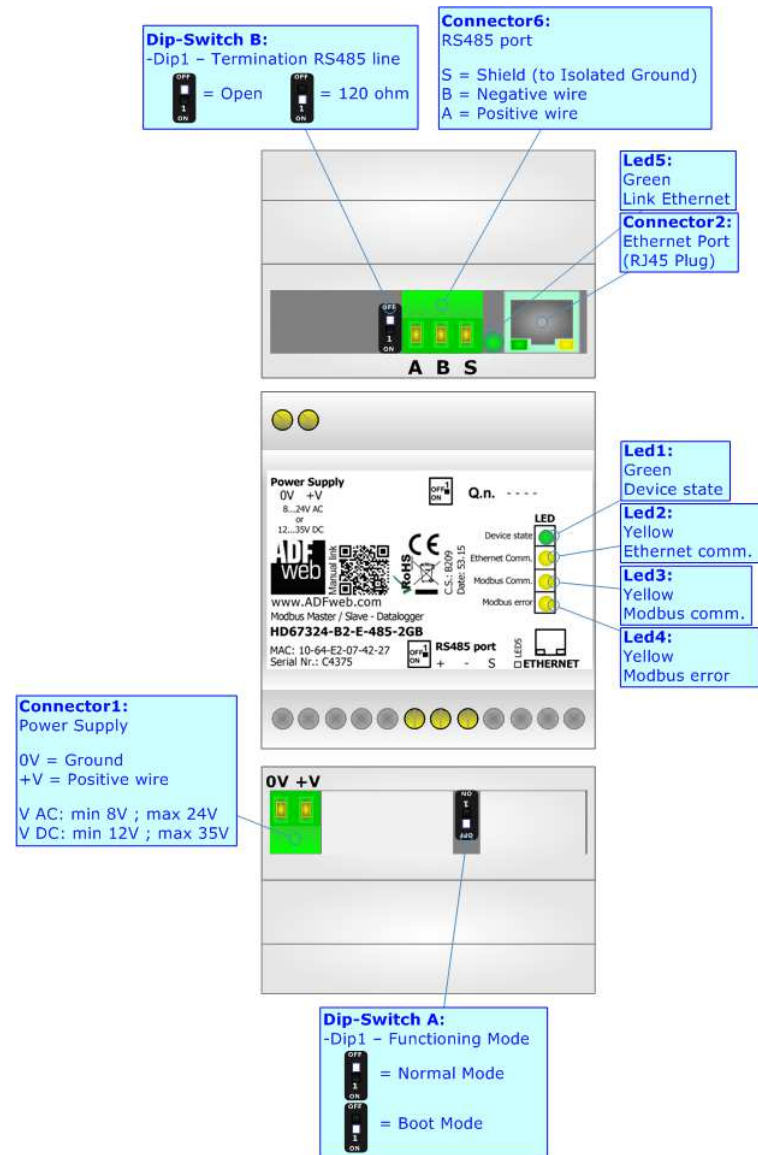

Figure 1b: Connection scheme for HD67324-B2-E-485-xGB

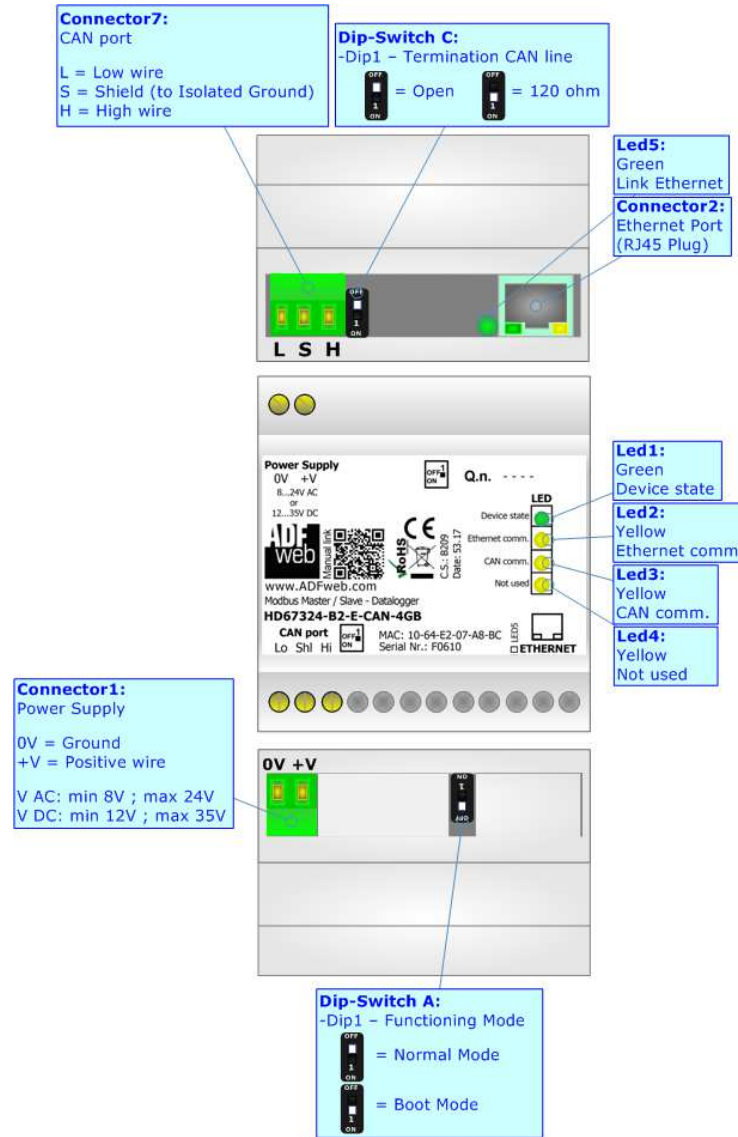

Figure 1b: Connection scheme for HD67324-B2-E-CAN-xGB

**CHARACTERISTICS:**

The HD67324 is a Modbus / CAN Datalogger.

It has the following characteristics:

- Electrical isolation for bus (RS232, RS485, CAN, Ethernet) connection;
- Mountable on Rail DIN;
- Power Supply 8...24V AC or 12...35V DC;
- Temperature range -20°C to 70°C.

**CONFIGURATION:**

You need Compositor SW67324 software on your PC in order to perform the following:

- Define the parameter of Modbus line;
- Set Time and Date;
- Manage the Datalogger's functions;
- Update the device.

**POWER SUPPLY:**

The devices can be powered at 8...24V AC and 12...35V DC. For more details see the two tables below.

VAC		VDC	
Vmin	Vmax	Vmin	Vmax
8V	24V	12V	35V

Consumption at 24V DC:

Device	Consumption [W/VA]
HD67324-B2-E-232/485-xGB	3.5
HD67324-B2-E-CAN-xGB	3.5

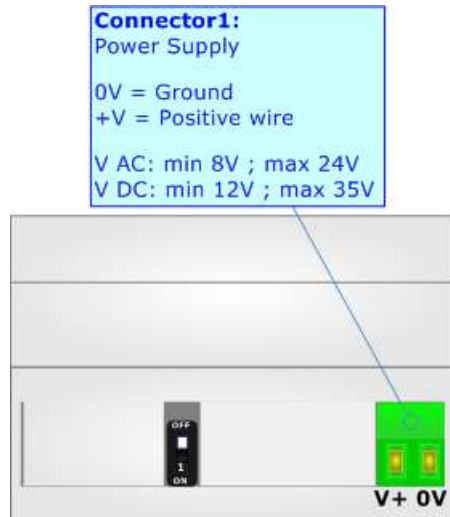

**Caution: Not reverse the polarity power**

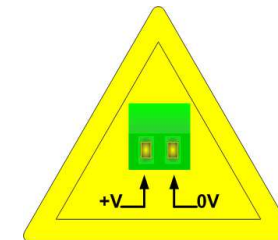

HD67324-B2-E-232/485-xGB  
HD67324-B2-E-CAN-xGB



**FUNCTION MODES:**HD67324-B2-E-xxx-xGB

The device has got two functions mode depending of the position of the 'Dip1 of Dip-Switch A':

- The first, with 'Dip1 of Dip-Switch A' at "OFF" position, is used for the normal working of the device.
- The second, with 'Dip1 of Dip-Switch A' at "ON" position, is used for upload the Project and/or Firmware.

For the operations to follow for the updating, see 'UPDATE DEVICE' section.

According to the functioning mode, the LEDs will have specifics functions, see 'LEDS' section.

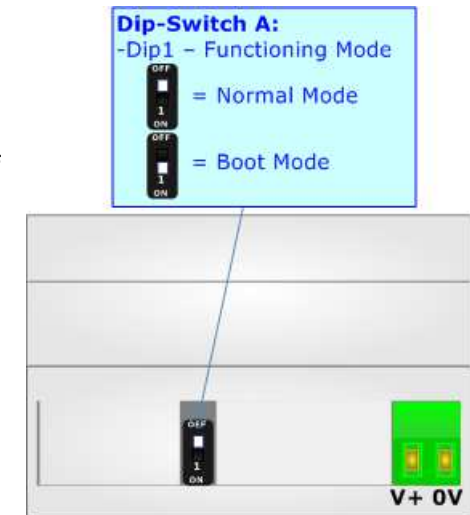

**LEDS:**

HD67324-B2-E-232-xGB

HD67324-B2-E-485-xGB

The device has got five LEDs that are used to give information of the functioning status.  
The various meanings of the LEDs are described in the table below.

LED	Normal Mode	Boot Mode
1: Device State (green)	Blinks slowly (~1Hz)	<b>Blinks quickly:</b> Boot state <b>Blinks very slowly (~0.5Hz):</b> update in progress
2: Ethernet communication (yellow)	Blinks when Ethernet request is received	<b>Blinks quickly:</b> Boot state <b>Blinks very slowly (~0.5Hz):</b> update in progress
3: Modbus communication (yellow)	Blinks when Modbus frame (RS232/RS485) is received	<b>Blinks quickly:</b> Boot state <b>Blinks very slowly (~0.5Hz):</b> update in progress
4: Modbus error (yellow)	<b>ON:</b> At least one Modbus request hasn't a correct response <b>OFF:</b> No errors are present	<b>Blinks quickly:</b> Boot state <b>Blinks very slowly (~0.5Hz):</b> update in progress
5: Ethernet Link (green)	<b>ON:</b> Ethernet cable connected <b>OFF:</b> Ethernet cable disconnected	<b>ON:</b> Ethernet cable connected <b>OFF:</b> Ethernet cable disconnected

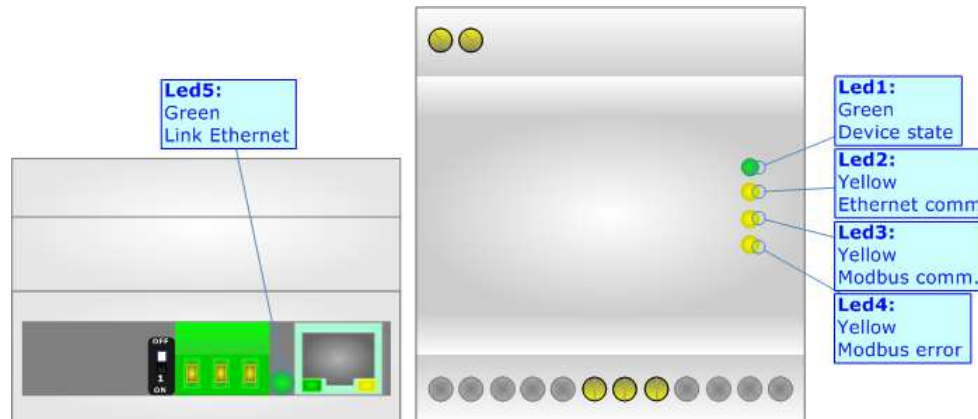

**HD67324-B2-E-CAN-xGB**

The device has got five LEDs that are used to give information of the functioning status.  
The various meanings of the LEDs are described in the table below.

LED	Normal Mode	Boot Mode
1: Device State (green)	Blinks slowly (~1Hz)	<b>Blinks quickly:</b> Boot state <b>Blinks very slowly (~0.5Hz):</b> update in progress
2: Ethernet communication (yellow)	Blinks when Ethernet request is received	<b>Blinks quickly:</b> Boot state <b>Blinks very slowly (~0.5Hz):</b> update in progress
3: CAN communication (yellow)	Blinks when a CAN frame is received	<b>Blinks quickly:</b> Boot state <b>Blinks very slowly (~0.5Hz):</b> update in progress
4: Not used (yellow)	OFF	<b>Blinks quickly:</b> Boot state <b>Blinks very slowly (~0.5Hz):</b> update in progress
5: Ethernet Link (green)	<b>ON:</b> Ethernet cable connected <b>OFF:</b> Ethernet cable disconnected	<b>ON:</b> Ethernet cable connected <b>OFF:</b> Ethernet cable disconnected

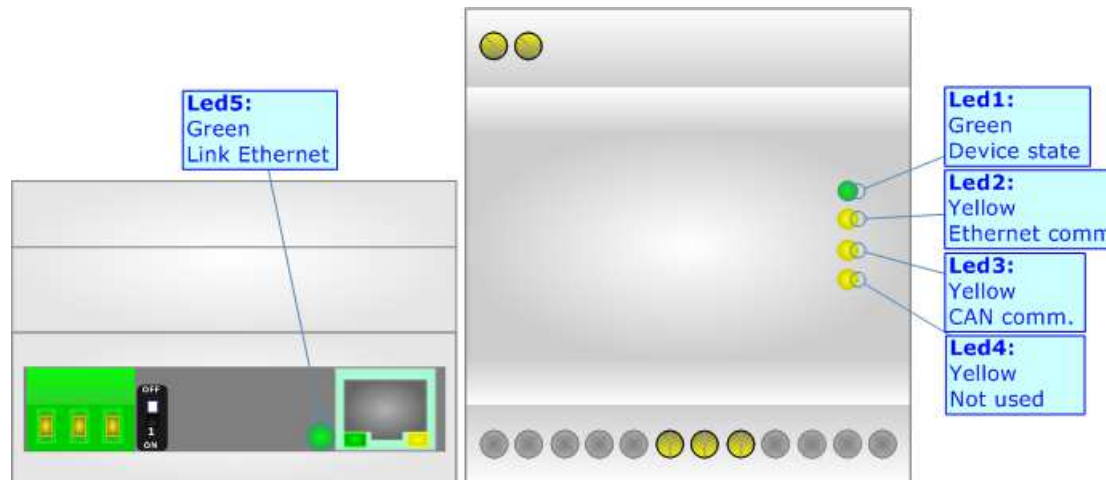

**RS232:**

The connection from RS232 socket to a serial port (example one from a personal computer) must be made with a NULL MODEM cable (a serial cable where the pins 2 and 3 are crossed).

It is recommended that the RS232 cable not exceed 15 meters.

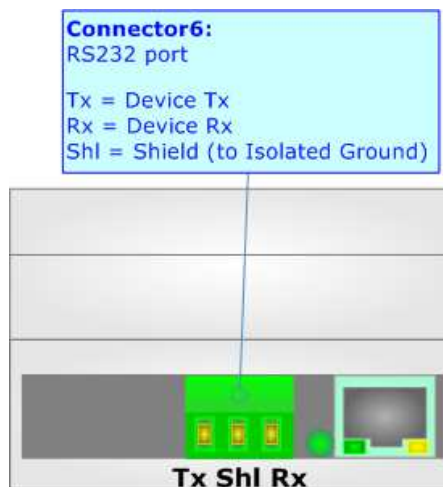

**RS485:**

For terminate the RS485 line with a 120Ω resistor it is necessary to put ON dip 1, like in figure.

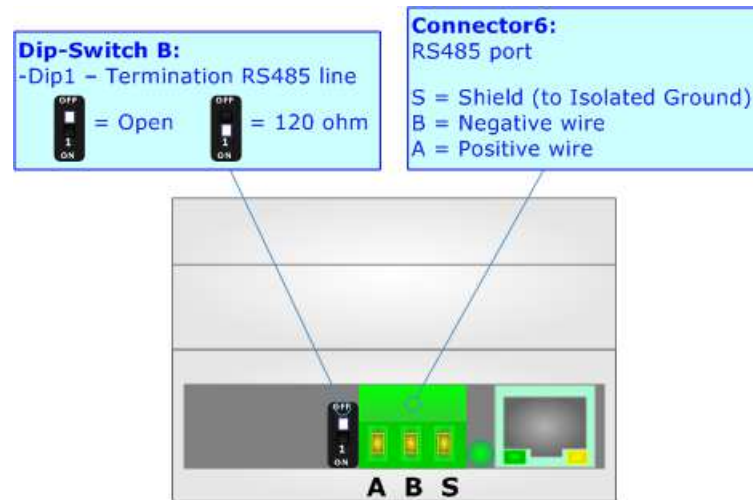

The maximum length of the cable should be 1200m (4000 feet).

Here some codes of cables:

- Belden: p/n 8132 - 2x 28AWG stranded twisted pairs conductor + foil shield + braid shield;
- Belden p/n 82842 - 2x 24AWG stranded twisted pairs conductor + foil shield + braid shield;
- Tasker: p/n C521 - 1x 24AWG twisted pair conductor + foil shield + braid shield;
- Tasker: p/n C522 - 2x 24AWG twisted pairs conductor + foil shield + braid shield.

**CAN:**

For terminating the CAN line with a 120Ω resistor it is necessary to put Dip1 of 'Dip-Switch C' at ON position.

Cable characteristics:

<b>DC parameter:</b>	Impedance	70 Ohm/m
<b>AC parameters:</b>	Impedance	120 Ohm/m
	Delay	5 ns/m

Length	Baud Rate [bps]	Length MAX [m]
	10 K	5000
	20 K	2500
	50 K	1000
	100 K	650
	125 K	500
	250 K	250
	500 K	100
	800 K	50
	1000 K	25

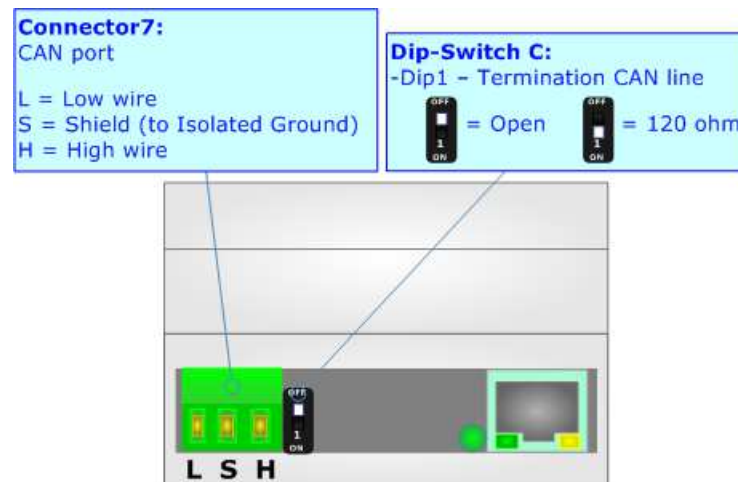

**ETHERNET:**

The Ethernet port is used for programming the device and managing the functions.

The Ethernet connection must be made using Connector2 of HD67324-B2-E-xxx-xGB with at least a Category 5E cable. The maximum length of the cable should not exceed 100m. The cable has to conform to the T568 norms relative to connections in cat.5 up to 100 Mbps. To connect the device to an Hub/Switch is recommended the use of a straight cable, to connect the device to a PC is recommended the use of a cross cable.

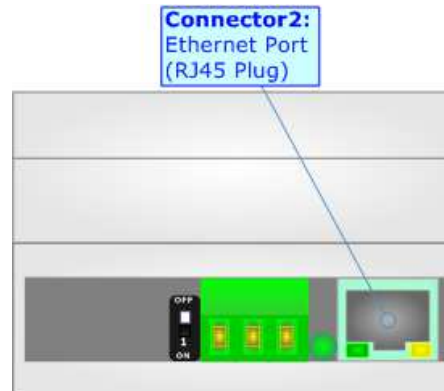

**USE OF COMPOSITOR SW67324:**

To configure the Datalogger, use the available software that runs with Windows called SW67324. It is downloadable on the site [www.adfweb.com](http://www.adfweb.com) and its operation is described in this document. *(This manual is referenced to the last version of the software present on our web site).* The software works with MSWindows (XP, Vista, Seven, 8, 10; 32/64bit).

When launching the SW67324, the window below appears (Fig. 2).

 **Note:**  
It is necessary to have installed .Net Framework 4.

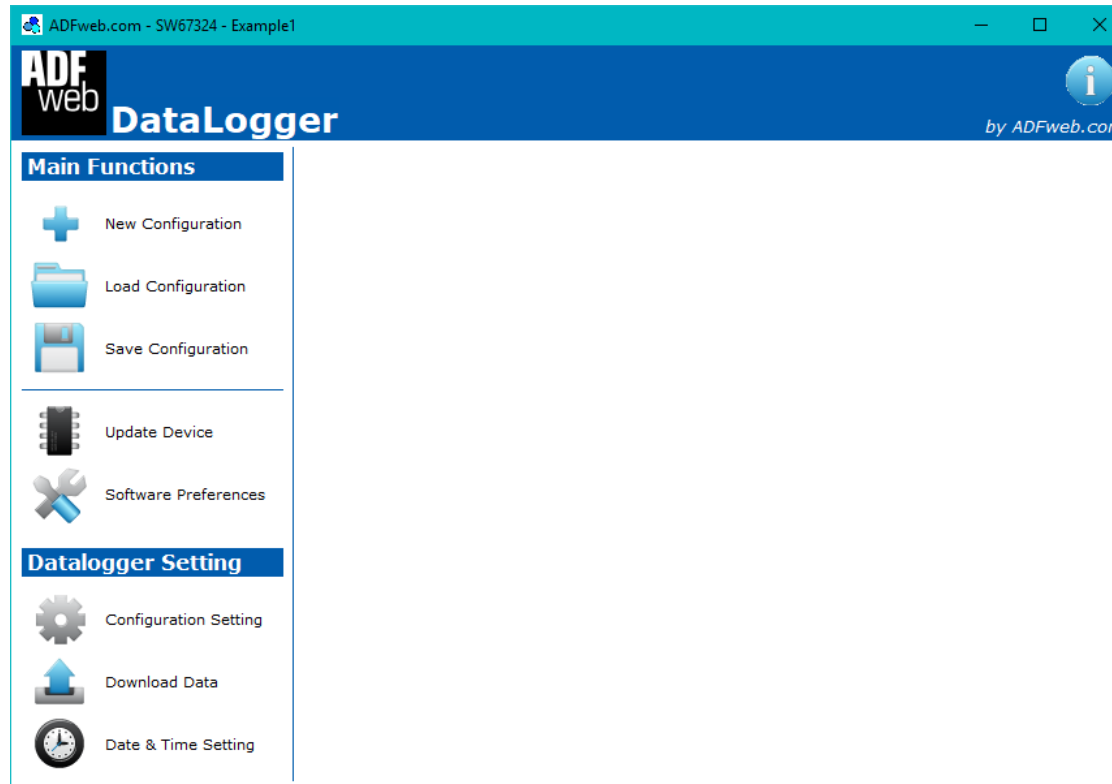
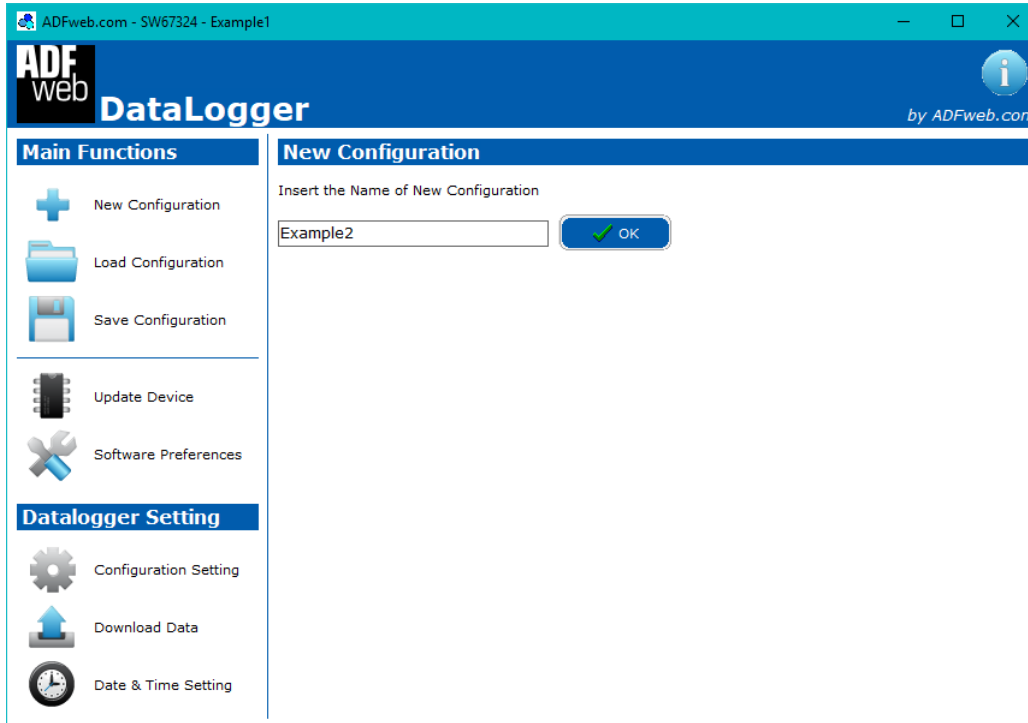

Figure 2: Main window for SW67324



**NEW CONFIGURATION:**



By pressing the “**New Configuration**” button it is possible to create a new project. It is possible to assign the name and confirm it by pressing the “OK” button.

Figure 3: “New Configuration” window

**LOAD CONFIGURATION:**

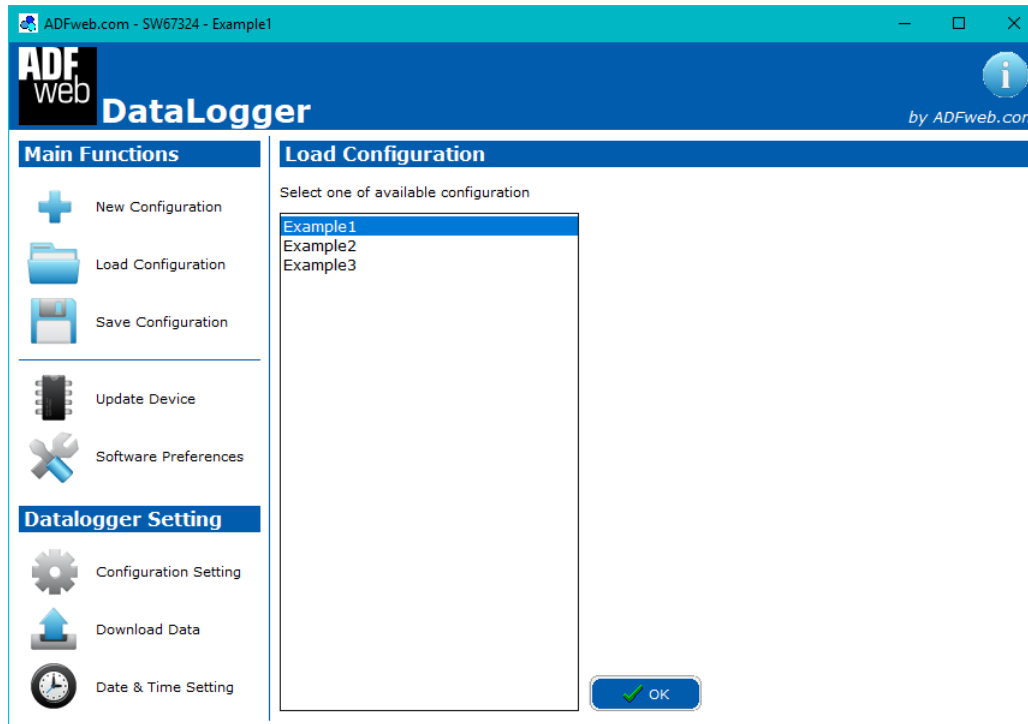

Figure 4: "Load Configuration" window

By pressing the "Load Configuration" button it is possible to load an existing project by selecting one of the list that appears.

A configuration can be imported or exported too:

- ✦ To clone the configurations of a Datalogger in order to configure another device in the same manner, it is necessary to maintain the folder and all its contents;
- ✦ To clone a project in order to obtain a different version of the project, it is sufficient to duplicate the project folder with another name and open the new folder with the button "Load Configuration".

**SAVE CONFIGURATION:**

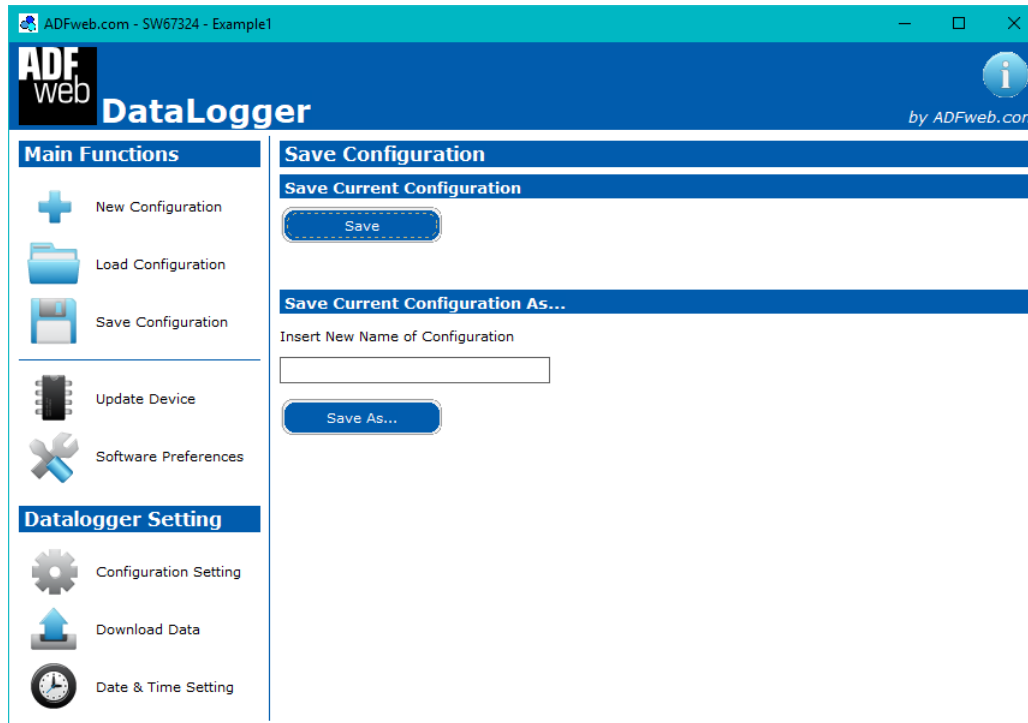

Figure 5: "Save Configuration" window

By pressing the "Save Configuration" button it is possible to save the project.

There are two possibilities: saving the current configuration, by pressing the button "Save" or saving it with a new name by pressing the button "Save As..." and writing the name in the field above the button.

**UPDATE DEVICE:**

Figure 6a: "Update Device" window (Ethernet version)

If you know the actual IP address of the device, you have to use this procedure:

- Turn ON the Device with the Ethernet cable inserted;
- Insert the actual IP of the Converter;
- Select which operations you want to do;
- Press the "**Execute update firmware**" button to start the upload;
- When all the operations are "OK" the device automatically goes at Normal Mode.

By pressing the "**Update Device**" button it is possible to load the created Configuration into the device; and also the Firmware, if is necessary.

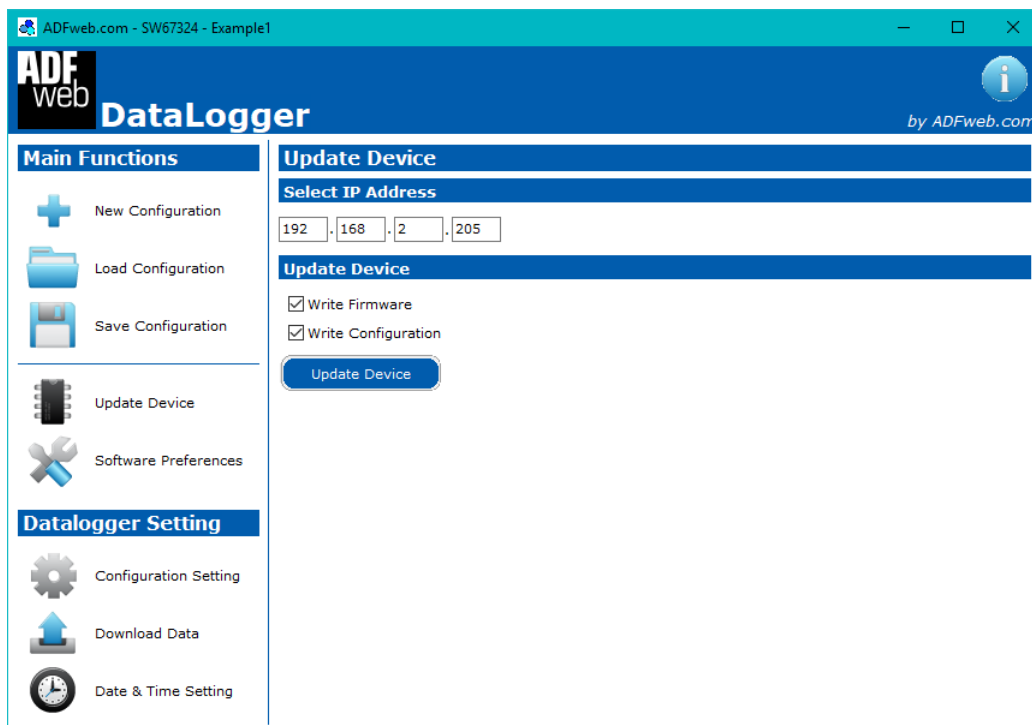
If the Ethernet version is used, in order to load the parameters or update the firmware in the device, follow these instructions:

- Turn OFF the Device;
- Put Dip1 of 'Dip-Switch A' in ON position;
- Turn ON the device
- Connect the Ethernet cable;
- Insert the IP "**192.168.2.205**";
- Select which operations you want to do;
- Press the "**Update Device**" button to start the upload;
- When all the operations are "OK" turn OFF the Device;
- Put Dip1 of 'Dip-Switch A' at OFF position;
- Turn ON the device.

If the USB version is used, in order to load the parameters or update the firmware in the device, follow these instructions:

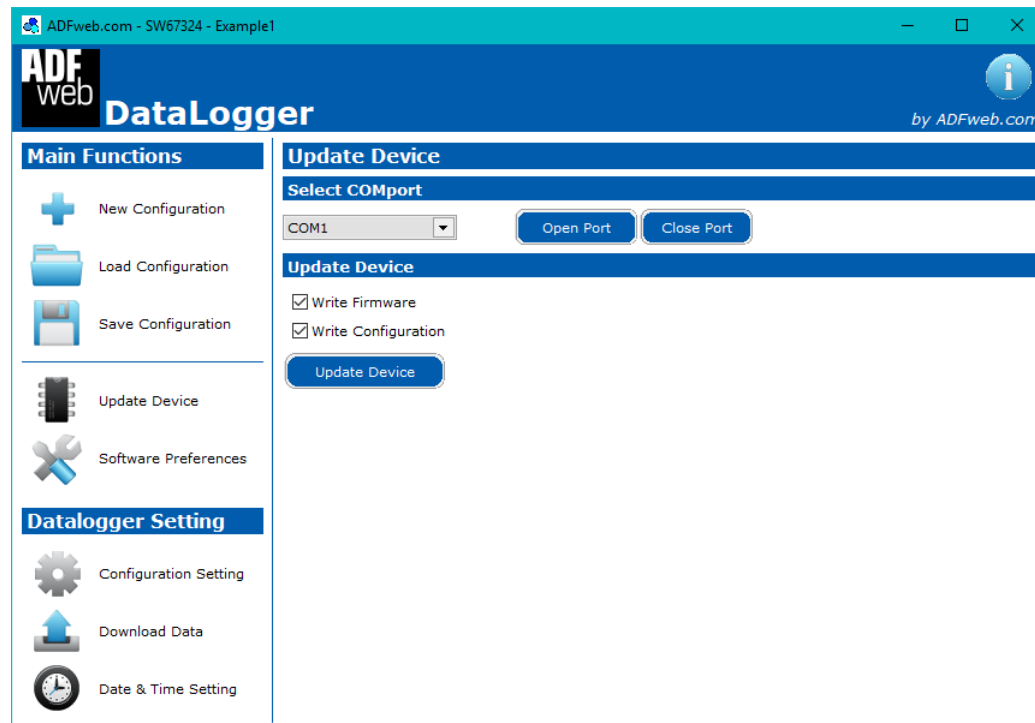

Figure 6b: "Update Device" window (USB version)

- Turn OFF the Device;
- Connect the USB cable from your PC to the device;
- Put Dip1 of 'Dip-Switch A' in ON position;
- Select the "COM port" and press the "Open Port" button;
- Turn ON the device;
- Check the "Device state" Led. It must blink quickly (see "LEDS" section);
- Select which operations you want to do;
- Press the "Update Device" button;
- When all the operations are "OK" turn OFF the device;
- Press the "Close Port" button;
- Put Dip1 of 'Dip-Switch A' in OFF position;
- Turn ON the device.



**Note:**

When you install a new version of the software, if it is the first time it is better you do the update of the Firmware in the HD67324 device.



**Note:**

When you receive the device, for the first time, you also have to update the Firmware in the HD67324 device.



**Warning:**

If Fig. 7 appears when you try to do the Update try these points before seeking assistance:

- Check if the serial COM port selected is the correct one;
- Check if the USB cable is connected between the PC and the device;
- Try to repeat the operations for the updating;
- Try with another PC;
- Try to restart the PC;
- Check the LAN settings;
- Check the Wi-Fi settings;
- If you are using the program inside a Virtual Machine, try to use in the main Operating System;
- If you are using Windows Seven, Vista, 8 or 10 make sure that you have the administrator privileges;
- In case you have to program more than one device, using the "Ethernet Update", you have to cancel the ARP table every time you connect a new device on Ethernet. For do this you have to launch the "Command Prompt" and write the command "arp -d". Pay attention that with Windows Vista, Seven, 8, 10 you have to launch the "Command Prompt" with Administrator Rights;
- Pay attention at Firewall lock.

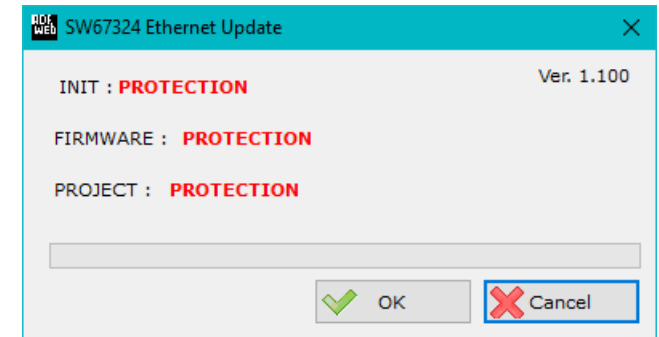

Figure 7: "Protection" window

In the case of HD67324 you have to use the software "SW67324": [www.adfweb.com/download/filefold/SW67324.zip](http://www.adfweb.com/download/filefold/SW67324.zip).

**SOFTWARE PREFERENCES:**

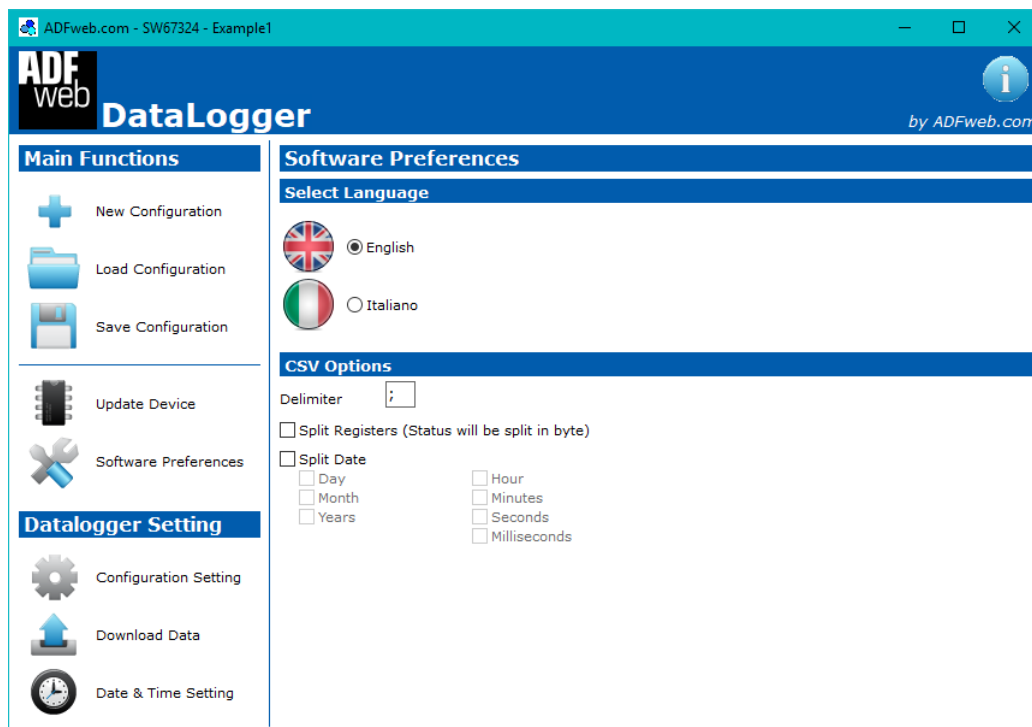

Figure 8: "Software Preferences" window

By pressing the "Software Preferences" button it is possible to select the preferences of the software SW67324.

**SELECT LANGUAGE**

In this section is possible to select the language of the software.

**CSV OPTIONS**

In this section is possible to select the options of the CSV file. In the field "Delimiter" the character to split the fields in CSV file is defined.

If the field "Split Register (Status will be split in byte)" is checked, the data of the Modbus registers are splitted per registers.

If the field "Split Date" is checked, the date and time of the data are splitted. It is possible to select the parts of the date and time to insert in CSV file, the fields selectable are:

**Day, Month, Year, Hour, Minutes, Seconds and Milliseconds.**

## CONFIGURATION SETTING:

By pressing the “**Configuration Setting**” button it is possible to configure the various informations that the DataLogger wants for functioning.

In relation to the hardware, it is possible to set:

- HD67324-U-Modbus (USB interface);
- HD67324-E-Modbus (Ethernet interface);
- HD67324-E-CAN (Ethernet interface).

## CONFIGURATION SETTING FOR MODBUS VERSION

### MAIN OPTION

The screenshot shows the 'DataLogger Setting' window with the 'Main Option' tab selected. The settings are as follows:

- Select Hardware of Datalogger: HD67324-E-Modbus
- Select Type of Datalogger:
  - Master
  - Sniffer
  - Slave
  - Slave + Sniffer
- Serial Baudrate: 9600
- Serial Parity: NONE
- TimeOut (ms): 1000
- Delay Req. (ms): 0
- Start Record when Reboot
- Cyclical Memory
- IP Address: 192 . 168 . 0 . 10
- SubNet Mask: 255 . 255 . 255 . 0
- Gateway: 192 . 168 . 0 . 1
- Time Server: 192 . 168 . 2 . 10
- Polling Time (s): 3600
- User: admin
- Password: admin

The Modbus DataLogger can act as ‘**Master**’, ‘**Slave**’, ‘**Sniffer**’ or ‘**Slave + Sniffer**’:

- Like “**Master**” it is the device that makes the requests for read the Coil Status, Input Status, Holding Register and Input Register. The Field “Slave ID” isn’t present with this mode.
- Like “**Slave**” it records all frames addressed to it. It answer with an exception if a master makes a Read Request, and answer correctly if a master makes a Write Request. The Field “Slave ID” is present with this mode.
- Like “**Sniffer**” it records all frames that pass in the line. The Field “Slave ID” isn’t present with this mode.
- Like “**Slave+Sniffer**” it records all frames that pass in the line. And more, it answer with an exception if a master makes a Read Request, and answer correctly if a master makes a Write Request. The Field “Slave ID” is present with this mode.

Figure 9a: “Configuration Settings->Main Option” window



About the meanings of the others fields:

- In the field "**Serial Baudrate**" the Baudrate of the serial line is defined;
- In the field "**Serial Parity**" the parity of the serial line is defined;
- In the field "**TimeOut (ms)**", the timeout for the Modbus requests is defined (only for Ethernet version and if 'Master' is set);
- In the field "**Delay Req. (ms)**", the idle time between two Modbus requests is defined (only for Ethernet version and if 'Master' is set);
- In the field "**Slave ID**" the id of the Data Logger, in the case of 'Slave' and 'Slave+Sniffer', is defined;
- If the field "**Start Record when Reboot**" is checked the Data Logger starts automatically to record data (when is in Normal Mode). Otherwise it is necessary to give the Start/Stop commands manually, by the software;
- If the field "**Cyclic Memory**" is checked the DataLogger, when the memory is finished, restart to save the data from the beginning. Otherwise, if the field isn't checked, when the memory is full the messages aren't stored and the Led1 blinks very slowly;

If the Ethernet version is used (HD67324-E-Modbus), it will be possible to set the Ethernet parameters too:

- In the field "**IP ADDRESS**" the IP address of the DataLogger is defined;
- In the field "**SUBNET Mask**" the SubNet Mask of the DataLogger is defined;
- In the field "**GATEWAY**" the default gateway of the network is defined. This feature can be enabled or disabled pressing the Check Box field. This feature is used for going out of the net;
- In the field "**Time Server**", the IP Address of the Time Server for Date and Time synchronization is defined. The synchronization time is defined in the field "**Polling Time (s)**". This option can be enabled/disabled by checkbox;
- In the field "**User**", the user name to access to the DataLogger is defined;
- In the field "**Password**", the password to access to the DataLogger is defined.

**POLLS TABLE**

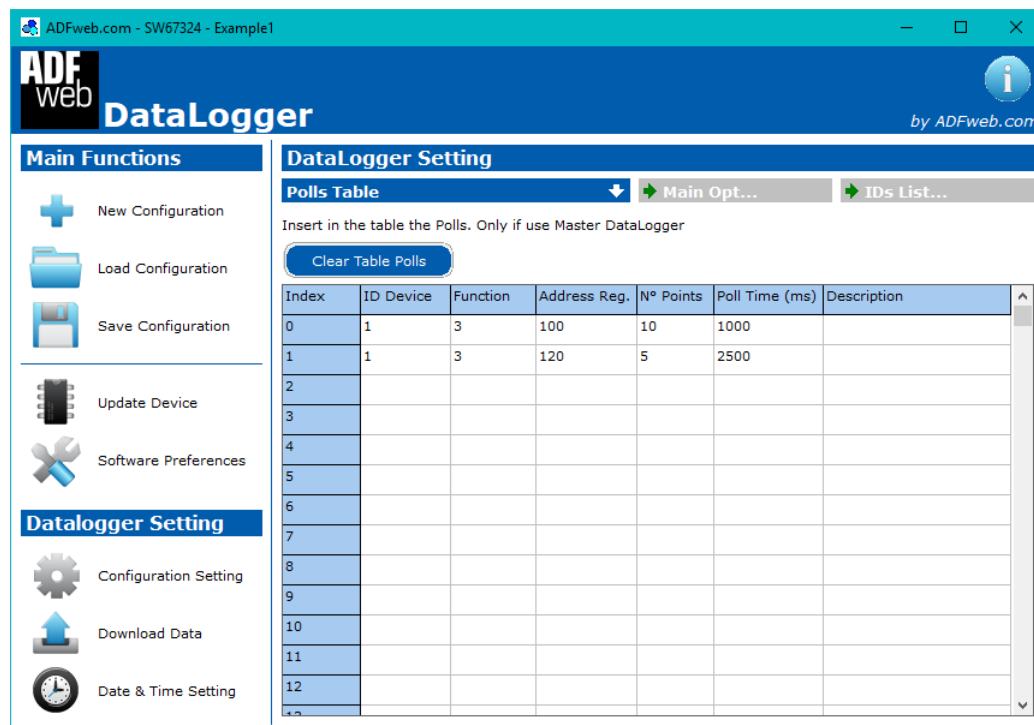

Figure 9b: "Configuration Settings->Polls Table" window

This section is used only if the Data Logger is set like 'Master'.

In the table the various requests that the Data Logger sends are defined.

The fields to compile are:

- "**ID Device**": ID of the slave device to which the request will be addressed;
- "**Function**": type of request used. It is possible to define 1: Coil Status, 2: Input Status, 3: Holding Register, 4: Input Register;
- "**Address Reg.**": starting address of the registers to be required;
- "**N° Points**": number of consecutive registers to be required;
- "**Poll Time [ms]**": time between two polls of the row;
- "**Description**": short description of the request.

It is possible to define up to 1024 different requests.

**IDS LIST**

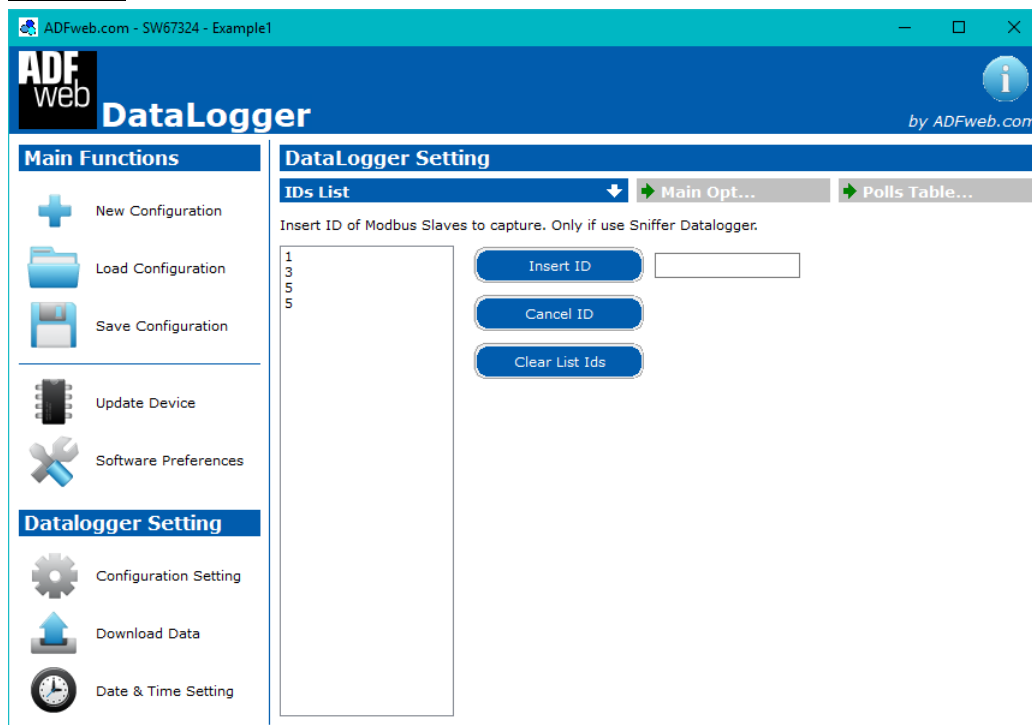

Figure 9c: "Configuration Settings->IDs List" window

This section is used only if the Data Logger is set like 'Sniffer' or "Slave + Sniffer".

In the left list, there are the IDs of the slaves that the Data Logger sniffs: the device will record all the requests/responses addressed to these IDs.

It is possible to define up to 247 IDs.

## **CONFIGURATION SETTING FOR CAN VERSION**

### **MAIN OPTION**

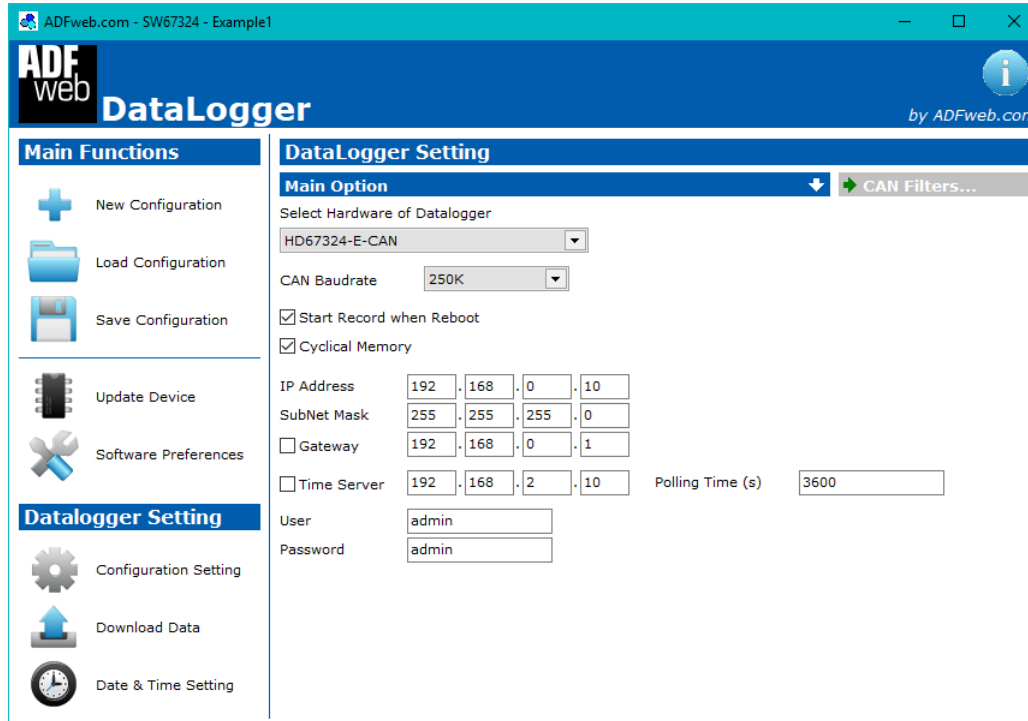

The screenshot shows the 'DataLogger Setting' window with the 'Main Option' tab selected. The settings are as follows:

- Select Hardware of Datalogger: HD67324-E-CAN
- CAN Baudrate: 250K
- Start Record when Reboot
- Cyclical Memory
- IP Address: 192 . 168 . 0 . 10
- SubNet Mask: 255 . 255 . 255 . 0
- Gateway: 192 . 168 . 0 . 1
- Time Server: 192 . 168 . 2 . 10
- Polling Time (s): 3600
- User: admin
- Password: admin

Figure 10a: "Configuration Settings->Main Option" window

About the meanings of the others fields:

- In the field "**CAN Baudrate**" the Baudrate of the CAN line is defined;
- If the field "**Start Record when Reboot**" is checked the Data Logger starts automatically to record data (when is in Normal Mode). Otherwise it is necessary to give the Start/Stop commands manually, by the software;
- If the field "**Cyclical Memory**" is checked the DataLogger, when the memory is finished, restart to save the data from the beginning. Otherwise, if the field isn't checked, when the memory is full the messages aren't stored and the Led1 blinks very slowly;
- In the field "**IP ADDRESS**" the IP address of the DataLogger is defined;
- In the field "**SUBNET Mask**" the SubNet Mask of the DataLogger is defined;
- In the field "**GATEWAY**" the default gateway of the network is defined. This feature can be enabled or disabled pressing the Check Box field. This feature is used for going out of the net;
- In the field "**Time Server**", the IP Address of the Time Server for Date and Time synchronization is defined. The synchronization time is defined in the field "**Polling Time (s)**". This option can be enabled/disabled by checkbox;
- In the field "**User**", the user name to access to the DataLogger is defined;
- In the field "**Password**", the password to access to the DataLogger is defined.

**CAN FILTERS**

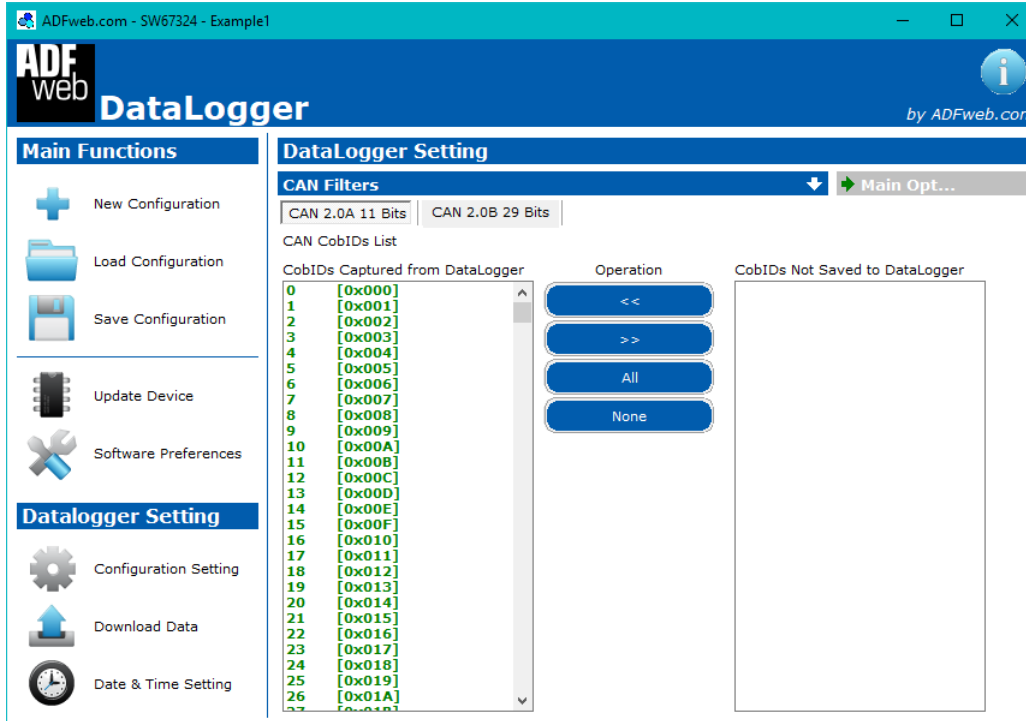

Figure 10b: "Configuration Settings->CAN Filters (11bit)" window

This section is used to define the CAN messages to log inside the DataLogger.

It is possible to define different filters in relation of the type of CAN communication used (CAN 2.0A and CAN 2.0B).

CAN 2.0A 11 BITS

In the table it is possible to list the COB-IDs of the CAN messages accepted and discharged.

The COB-IDs listed in the "CobIDs Captured from DataLogger" list are logged by the DataLogger. The ones listed in the "CobIDs Not Saved to DataLogger" are discharged.

**CAN 2.0B 29 BITS**

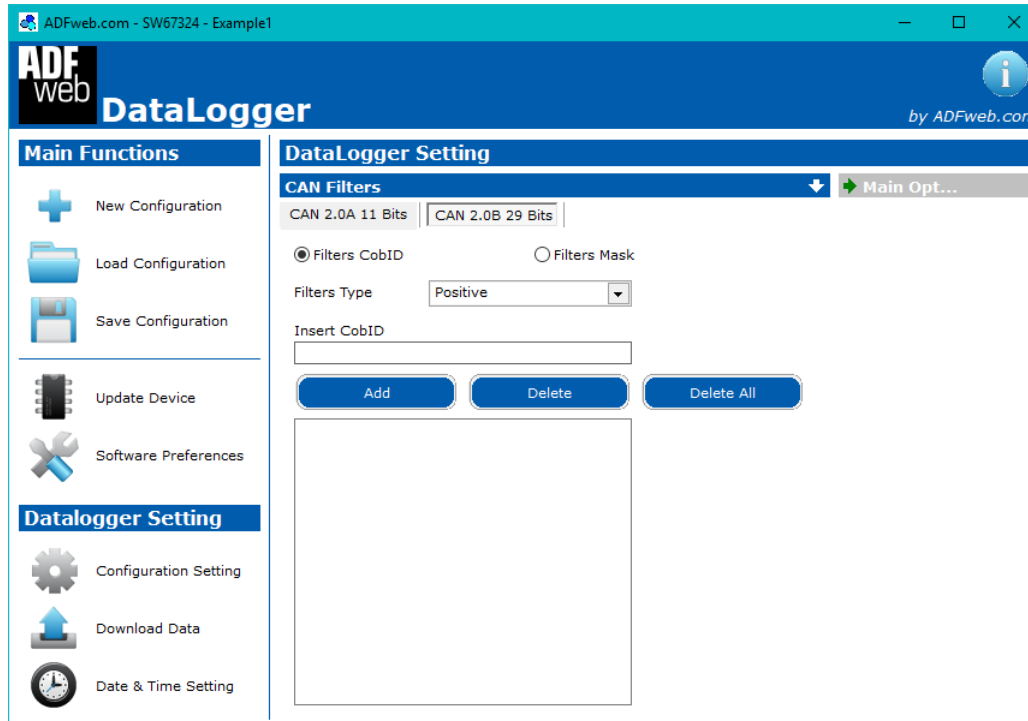

Figure 10c: "Configuration Settings->CAN Filters (29bit)" window

For CAN 2.0B messages, it is possible to define two type of filters:

- Filters CobID: the DataLogger will accept/discard specific CAN messages defined in the list.
- Filters Mask: it is possible to define specific bits of the COB-IDs that must have a specific values and others that can change.

If the "Filters CobID" is set, the fields below have this meaning:

- In the field "**Filters Type**" the type of filter used is defined. If "Positive" is set, the DataLogger will log the COB-IDs listed, if "Negative" the DataLogger will discard the COB-IDs listed;
- In the field "**Insert CobID**" the COB-ID to add to the list is defined. It is possible to Add and Delete the COB-IDs by clicking in the buttons "Add", "Delete" or "Delete All".

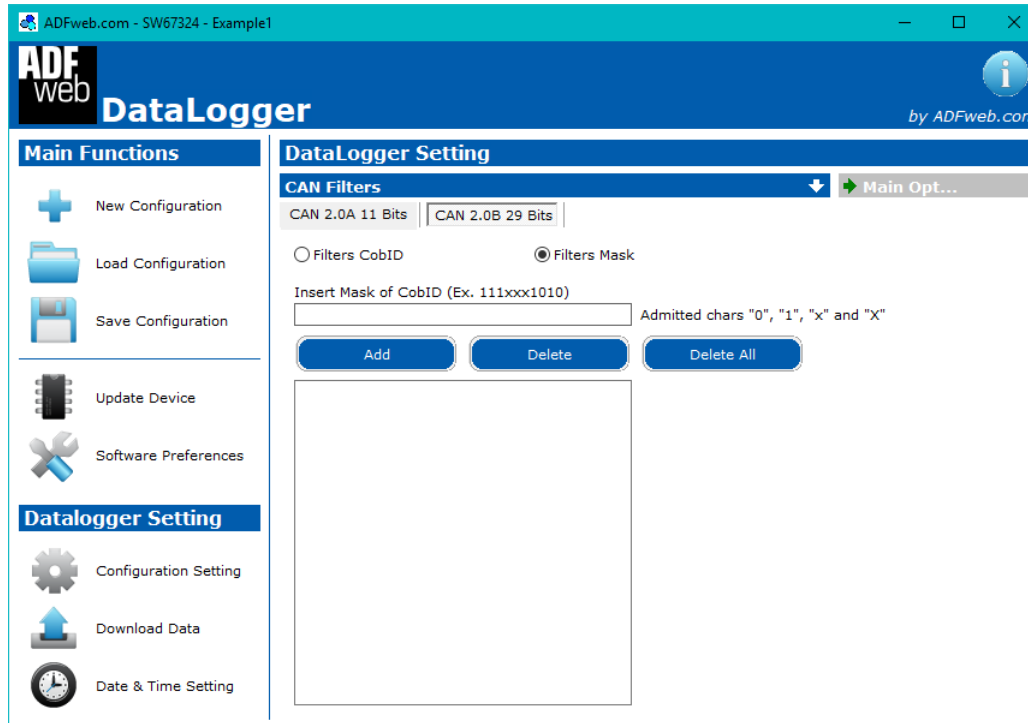

Figure 10d: "Configuration Settings->CAN Filters (29bit)" window

If the "Filters Mask" is set, the fields below have this meaning:

- ✦ In the field "**Insert Mask of CobID**" the Mask for the COB-IDs is defined. It is possible to define the bits with fixed values ('1' or '0') and with not fixed values ('x' or 'X'). It is possible to Add and Delete the Masks by clicking in the buttons "Add", "Delete" or "Delete All".

**DOWNLOAD DATA:**

By pressing the “**Download Data**” button it is possible to download the stored data of the DataLogger and see them in a grid.

**GET DATA**

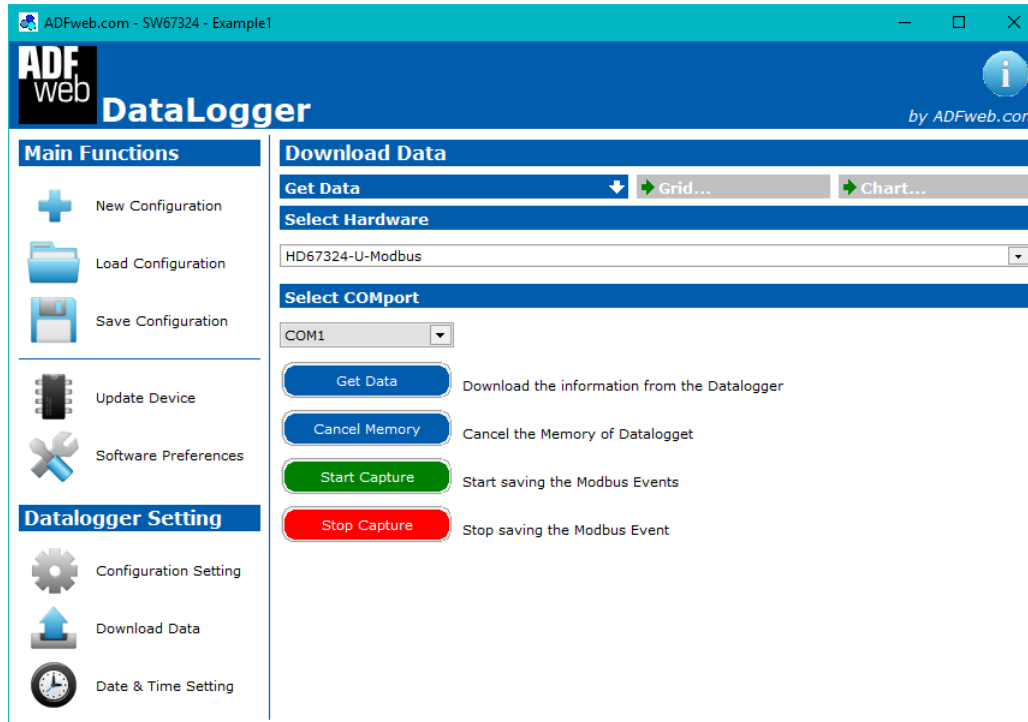

Figure 11a: “Download Data->Get Data” window

After selecting the correct COM port or the Ethernet settings, by pressing the “**Get Data**” button the software downloads the data from the Data Logger.

If the “**Cancel Memory**” button is pressed, the entire memory of Data Logger is cleared.

It is possible to stop the capturing of data by pressing the “**Stop Capture**” button, or resume by pressing the “**Start Capture**” button.



**GRID**

The screenshot shows the 'DataLogger RS485' web interface. The 'Download Data' window is active, displaying a table titled 'Grid'. The table has columns for Index, Date Time, Slave ID, Data Type, Address Register, Number of Registers, and Data. Below the table is a 'Save in CSV file' button.

Index	Date Time	Slave ID	Data Type	Address Register	Number	Data
29	29/7/2011 14.18.35.983.1	1	Holding Regi	120	15	[0] [0] [0] [0] [0] [0]
30	29/7/2011 14.18.36.392.9	1	Input Regist	150	30	[0] [0] [0] [0] [0] [0]
31	29/7/2011 14.18.36.442.3	1	Coil Status	100	10	[0] [0]
32	29/7/2011 14.18.37.43.3	1	Input Status	110	1	[0]
33	29/7/2011 14.18.37.538.7	1	Coil Status	100	10	[0] [0]
34	29/7/2011 14.18.37.649.7	1	Holding Regi	120	15	[0] [0] [0] [0] [0] [0]
35	29/7/2011 14.18.38.417.6	1	Input Status	110	1	[0]
36	29/7/2011 14.18.38.589.1	1	Input Regist	150	30	[0] [0] [0] [0] [0] [0]
37	29/7/2011 14.18.38.634.1	1	Coil Status	100	10	[0] [0]
38	29/7/2011 14.18.39.277.9	1	Holding Regi	120	15	[0] [0] [0] [0] [0] [0]
39	29/7/2011 14.18.39.740.4	1	Coil Status	100	10	[0] [0]
40	29/7/2011 14.18.39.787.8	1	Input Status	110	1	[0]
41	29/7/2011 14.18.40.792.9	1	Input Regist	150	30	[0] [0] [0] [0] [0] [0]
42	29/7/2011 14.18.40.834.6	1	Coil Status	100	10	[0] [0]
43	29/7/2011 14.18.40.953.3	1	Holding Regi	120	15	[0] [0] [0] [0] [0] [0]
44	29/7/2011 14.18.41.146.6	1	Input Status	110	1	[0]
45	29/7/2011 14.18.41.948.6	1	Coil Status	100	10	[0] [0]

Figure 11b: "Download Data->Grid" window

In this section there is the grid with the downloaded data.

For Modbus version, the grid is composed of the following fields:

- "Date Time": date and time of the request/response;
- "Slave ID": ID of the slave device that has replied;
- "Data Type": type of reply;
- "Address Register": starting address of the reply;
- "Number of Registers": number of consecutive registers of the reply;
- "Data": data read. The value is expressed in decimal format.

For CAN version, the grid is composed of the following fields:

- "Date Time": date and time of the request/response;
- "CobID": the COB-ID of the CAN message;
- "Type": type of CAN used;
- "RTR": RTR enabled or disabled;
- "Lenght": number of bytes of the CAN message;
- "Data": data of the CAN message. The value is expressed in decimal format.

By pressing the "Save in CSV file" button it is possible to export the data into a CSV file.

### DATE & TIME SETTING:

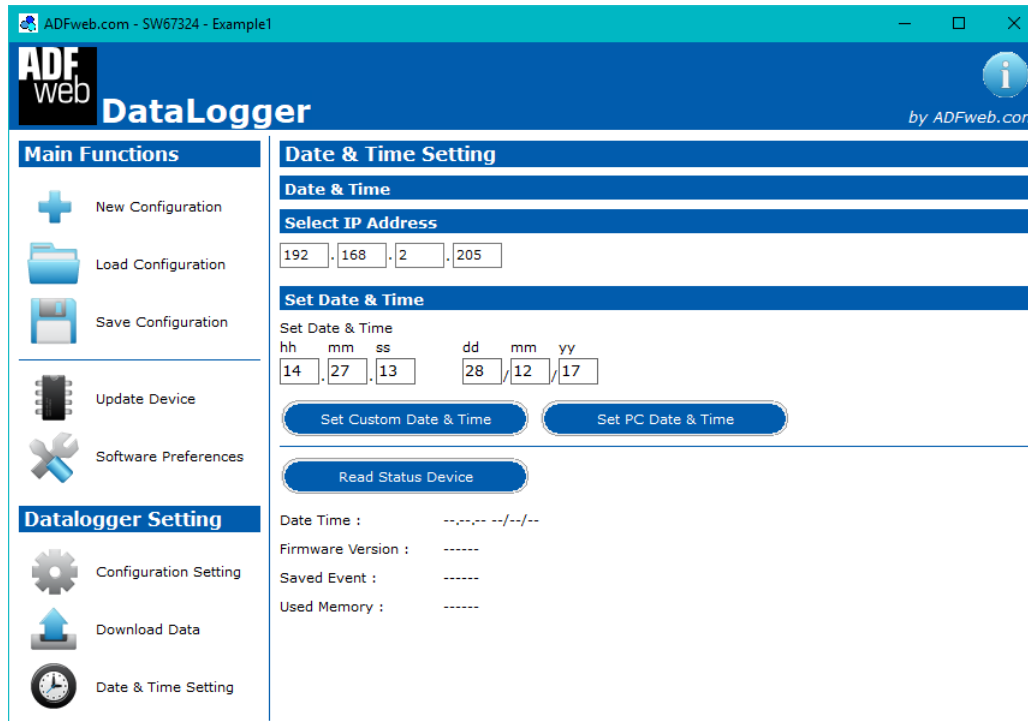

Figure 12: "Date & Time Setting" window

By pressing the "**Date & Time Setting**" button it is possible to update/read the Data Logger data/time and having others informations.

After selecting the correct COM port where the Data Logger is connected to the PC (or the IP Address for the Ethernet version), by pressing the "**Set Custom Date & Time**" it is possible to set the data/time that is written in the fields upper; by pressing the "**Set PC Date & Time**" button the data set are the ones of the PC.

By pressing the "**Read Status Device**" are read some information about the Data Logger:

- "**Data Time**": current data and time of the Data Logger;
- "**Firmware Version**": firmware version of the Data Logger;
- "**Saved Event**": number of Modbus events and some other commands saved;
- "**Used Memory**": number of bytes used by the Data Logger for storing data.

**WEBSERVER INTERFACE (only Modbus version):**

The HD67324-B2-E-xxx-4GB has an integrated Webserver that allows to managed the Data Logger's functions and download the data as Binary File. It is possible to use the most common browser like Internet Explorer, Google Chrome, Mozilla Firefox by editing the IP Address programmed inside the Data Logger in the address bar of the browser.

**WELCOME**

Figure 13: "Welcome" window

As soon as the connection to the Webserver interface of the Data Logger is done, "**Welcome**" window appears (Fig. 13). It has the following structure:

- "**Welcome**" button: it is possible to go to the starting page of the Webserver;
- "**Time & Date**" button: it is possible to open the section for the Time and Date setting;
- "**DLOG Commands**" button: it is possible to open the page for the Data Logger Management;
- "**DOWNLOAD ALL**" button: it is possible to download the logged data as Binary File.

When one of the buttons of the "Welcome" page are pressed, it is necessary to do the login, using the "Admin" and "Password" defined in the section "Configuration Setting → Main Option" of SW67324 (Fig. 14).

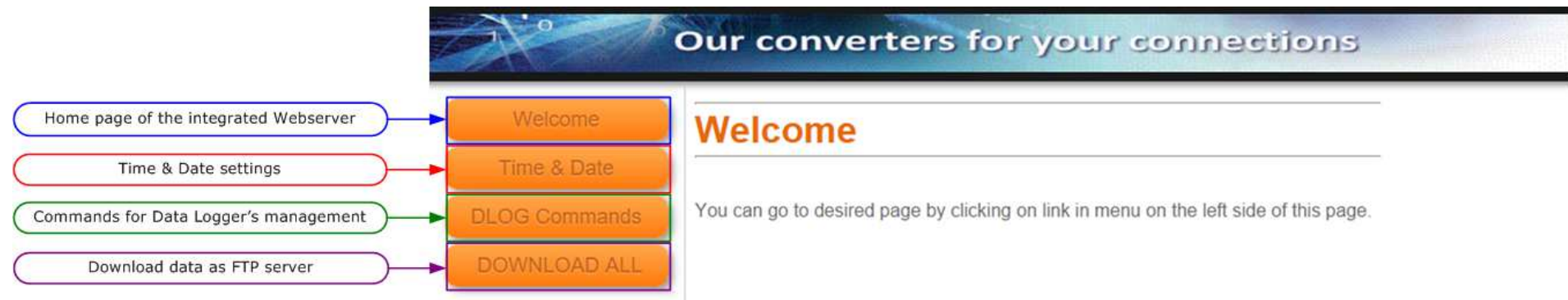
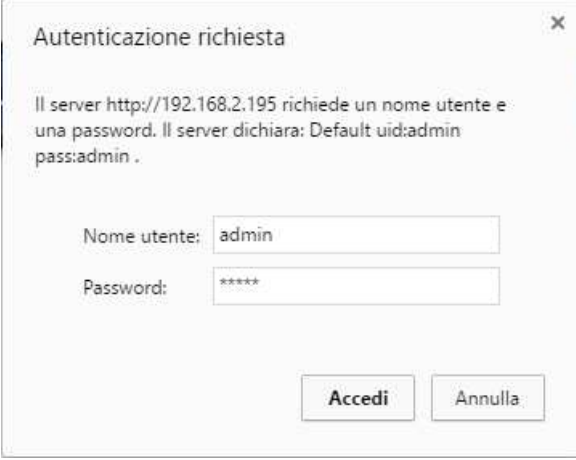

Autenticazione richiesta

Il server http://192.168.2.195 richiede un nome utente e una password. Il server dichiara: Default uid:admin pass:admin .

Nome utente:

Password:

Figure 14: "Login" window

**TIME & DATE**

Figure 15: "Data Logger Time & Date" window

When the "Time & Date" button is pressed, the "**Data Logger Time & Date**" window appears (Fig. 15). It has the following structure:

- "**Time and Date**" fields (Fig. 15, Point 1): the time and the date to be written in the Data Logger is defined;
- "**Set**" button (Fig. 15, Point 2): it is possible to write time and date defined;
- "**Actual Time**" (Fig. 15, Point 3): the actual time inside the Data Logger is displayed;
- "**Actual Date**" (Fig. 15, Point 4): the actual date inside the Data Logger is displayed;
- "**Functioning Time**" (Fig. 15, Point 5): the functioning time (from the last power ON) is displayed.

**DLOG COMMANDS**

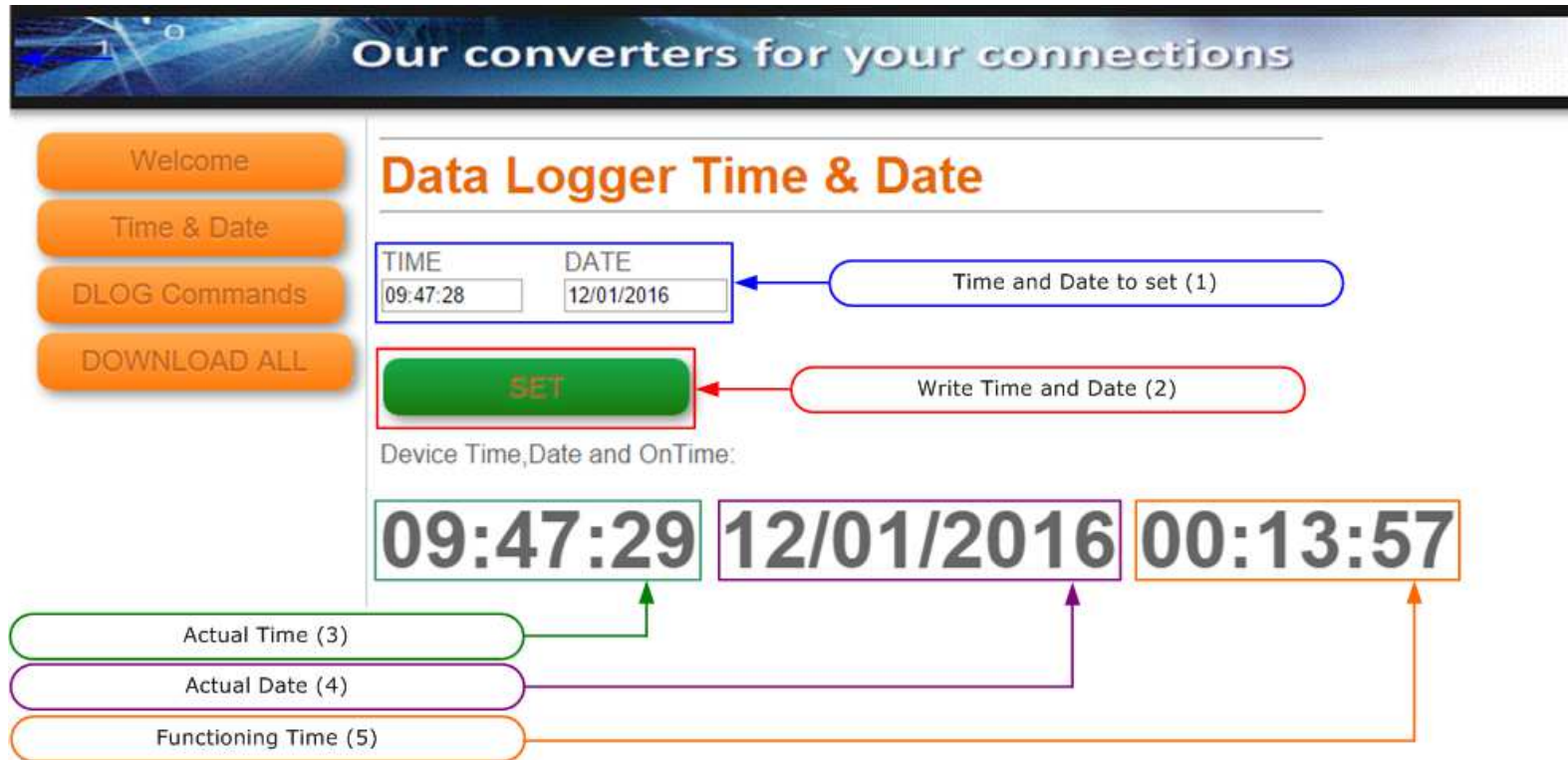
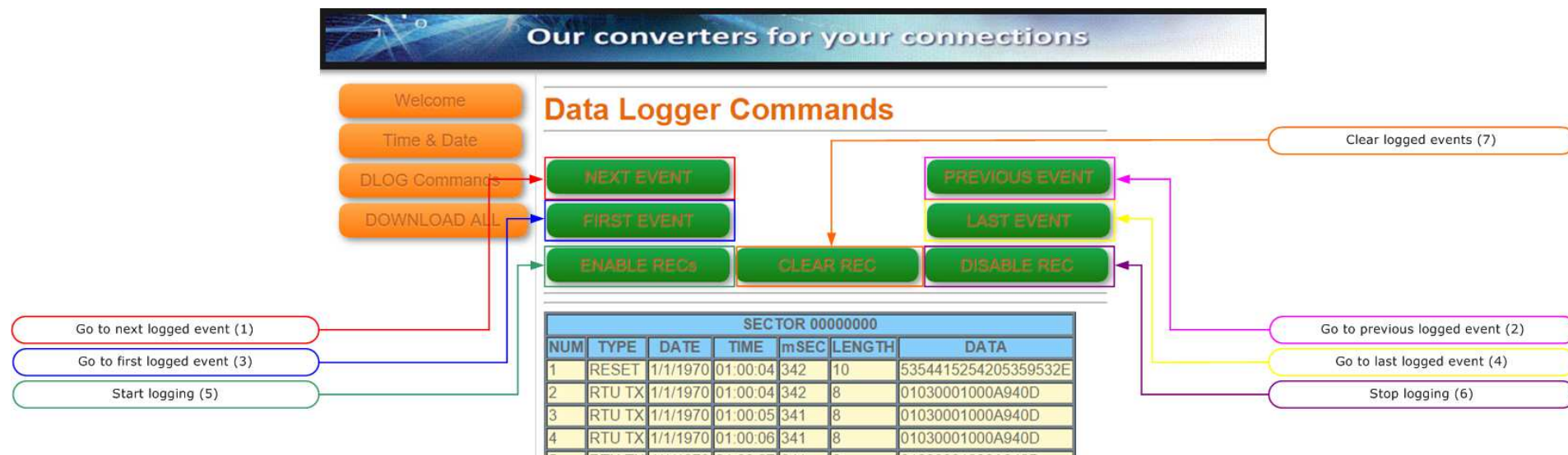

Figure 16: "Data Logger Commands" window

When the "DLOG Commands" button is pressed, the "Data Logger Commands" window appears (Fig. 16). It has the following structure:

- "NEXT EVENT" button (Fig. 16, Point 1): it is possible to go to the next logged event;
- "PREVIOUS EVENT" button (Fig. 16, Point 2): it is possible to go to the previous logged event;
- "FIRST EVENT" (Fig. 16, Point 3): it is possible to go to the first logged event;
- "LAST EVENT" (Fig. 16, Point 4): it is possible to go to the last logged event;
- "ENABLE REC" (Fig. 16, Point 5): it is possible to start the logging;
- "DISABLE REC" (Fig. 16, Point 6): it is possible to stop the logging;
- "CLEAR REC" (Fig. 16, Point 7): it is possible to clear the logged events.

When the logged events are displayed, the events' table has these fields:

- "**NUM**" fields: the number of the event is defined;
- "**TYPE**" fields: the type of event is defined;
- "**DATE**" fields: the date when the event was logged is defined;
- "**TIME**" and "**mSEC**" fields: the time when the event was logged is defined;
- "**LENGHT**" fields: the length of the message is defined;
- "**DATA**" fields: the data of the message is defined.

**MECHANICAL DIMENSIONS:**

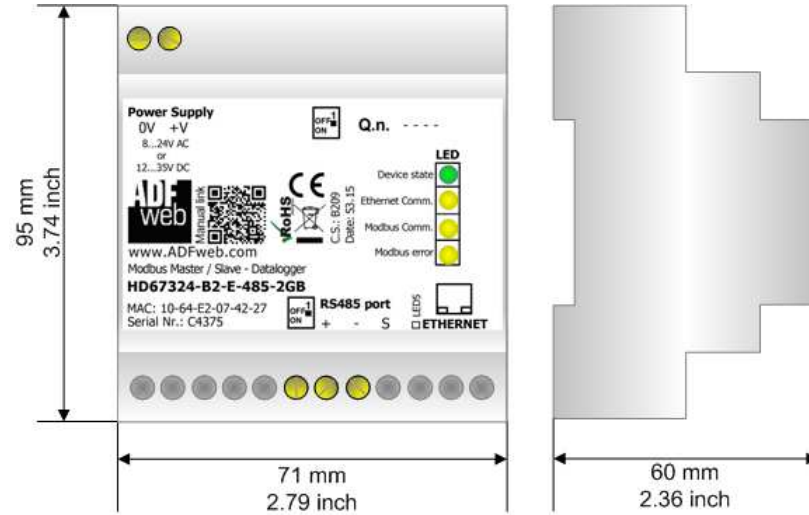

Housing: PVC  
Weight: 200g (Approx)

Figure 17: Mechanical Dimensions for HD67324-B2-E-xxx-4GB



**ORDERING INFORMATIONS:**

The ordering part number is formed by a valid combination of the following:

**HD67324 - B 2 - x - xxx - 4GB**

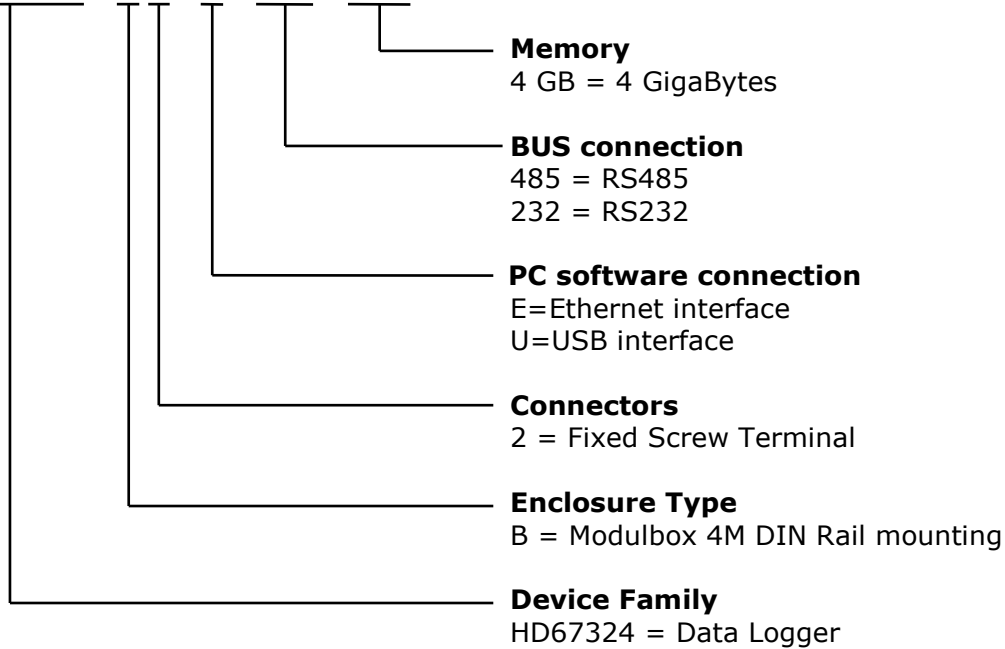

- Order Code: **HD67324-B2-E-485-4GB**      Data Logger for Modbus on RS485 with 4 Gigabytes of memory (Ethernet interface)
- Order Code: **HD67324-B2-E-232-4GB**      Data Logger for Modbus on RS232 with 4 Gigabytes of memory (Ethernet interface)
- Order Code: **HD67324-B2-E-CAN-4GB**      Data Logger for CAN with 4 Gigabytes of memory (Ethernet interface)

**ACCESSORIES:**

- AC34107** - Null Modem Cable Fem/Fem DSub 9 Pin 1,5 m
- AC34114** - Null Modem Cable Fem/Fem DSub 9 Pin 5 m
- AC34001** - Rail DIN Power Supply 220/240V AC 50/60Hz – 12 VAC
- AC34002** - Rail DIN Power Supply 110V AC 50/60Hz – 12 VAC

**DISCLAIMER:**

All technical content within this document can be modified without notice. The content of the document is a under continual renewal. For losses due to fire, earthquake, third party access or other accidents, or intentional or accidental abuse, misuse, or use under abnormal conditions repairs are charged to the user. ADFweb.com S.r.l. will not be liable for accidental loss of use or inability to use this product, such as loss of business income. ADFweb.com S.r.l. shall not be liable for consequences of improper use.

**OTHER REGULATIONS AND STANDARDS:****WEEE INFORMATION**

Disposal of old electrical and electronic equipment (as in the European Union and other European countries with separate collection systems).

— This symbol on the product or on its packaging indicates that this product may not be treated as household rubbish. Instead, it should be taken to an applicable collection point for the recycling of electrical and electronic equipment. If the product is disposed correctly, you will help prevent potential negative environmental factors and impact of human health, which could otherwise be caused by inappropriate disposal. The recycling of materials will help to conserve natural resources. For more information about recycling this product, please contact your local city office, your household waste disposal service or the shop where you purchased the product.

**RESTRICTION OF HAZARDOUS SUBSTANCES DIRECTIVE**

The device respects the 2002/95/EC Directive on the restriction of the use of certain hazardous substances in electrical and electronic equipment (commonly referred to as Restriction of Hazardous Substances Directive or RoHS).

**CE MARKING**

The product conforms with the essential requirements of the applicable EC directives.

**WARRANTIES AND TECHNICAL SUPPORT:**

For fast and easy technical support for your ADFweb.com SRL products, consult our internet support at [www.adfweb.com](http://www.adfweb.com). Otherwise contact us at the address [support@adfweb.com](mailto:support@adfweb.com)

**RETURN POLICY:**

If while using your product you have any problem and you wish to exchange or repair it, please do the following:

- Obtain a Product Return Number (PRN) from our internet support at [www.adfweb.com](http://www.adfweb.com). Together with the request, you need to provide detailed information about the problem.
- Send the product to the address provided with the PRN, having prepaid the shipping costs (shipment costs billed to us will not be accepted).

If the product is within the warranty of twelve months, it will be repaired or exchanged and returned within three weeks. If the product is no longer under warranty, you will receive a repair estimate.



**ADFweb.com S.r.l.**  
Via Strada Nuova, 17  
IT-31010 Mareno di Piave  
TREVISO (Italy)  
Phone +39.0438.30.91.31  
Fax +39.0438.49.20.99  
[www.adfweb.com](http://www.adfweb.com)

